

400 Hz CABLES

FOR GROUND POWER SUPPLY



Ground **S**upport **E**quipment

400 Hz Ground Power

Content

Who we are	3
400 Hz Ground Power supply cables	
... for fixed installation	
■ GP 400 Sy 400 Hz Ground Power supply cable - Symmetrical	4
... for flexible application	
■ GP 400 SC 400 Hz Ground Power supply cable - SingleCore	5
■ GP 400 QF 400 Hz Ground Power supply cable - QuadFlex	5
■ GP 400 7F 400 Hz Ground Power supply cable - SevenFlex	6
■ GP 400 SF 400 Hz Ground Power supply cable - SymmetricalFlex	7
400 Hz for cables boarding bridges	
■ GP 400 SF S 400 Hz Ground Power supply cable	8
■ GP 400 SF S 400 Hz Ground Power control cable	9
28 V DC cables	
... for flexible application	
■ GP 400 SC DC Ground Power supply cable 28 V DC - SingleCore Direct Current	10
■ GP 400 SF 28V DC 400 Hz Ground Power supply cable 28 V DC	11
Cable harnessing	
■ SAB 400 Hz cable for mobile GPUs with connectors	12
... Plug'n'Play - ready harnessed with connector	
■ Ready-to-connect ground power cables with connectors	13



Family business in the third generation

75 years of experience in cable and wire manufacturing as well as in temperature measurement technology turned a one-man business into a company with more than 550 employees. We prove our strength every year with more than 1500 special products according to customers' requirements. Each product is a new challenge for our creative technical team. We at **SAB** see ourselves as a manufacturer and a service provider – in the sense of true partnership and the greatest possible customer orientation.

Today, the quality of our products is known and appreciated in more than 100 countries around the world. In all product ranges, we are certified according to DIN EN ISO 9001. Furthermore, we have implemented an environmental management system for our company according to DIN EN ISO 14001, an occupational health and safety management system according to NLF/ILO-OSH and DIN ISO 45001, and an energy management system according to DIN EN ISO 50001.

And also for the future, our slogan is: **"WE GO FORWARD!"**

FOUNDED:	1947 by Peter Bröckskes sen. an independent, medium-sized company.
CEO:	Peter Bröckskes and Sabine Bröckskes-Wetten
PLANT/LOCATION:	In Viersen (Lower Rhine) 110.000 m ² company site. Own manufacturing from copper conductor to outer sheath. VDE approved burnchamber and laboratory within the company.
EMPLOYEES/WORKERS:	approx. 430 at the plant in Viersen, 550 worldwide
YEARLY SALES:	over 134 Mio. € worldwide
PRODUCTS:	Special Cables Measurement Technology Cable Harnessing
CERTIFICATES AND APPROVALS:	Quality management system acc. to DIN EN ISO 9001 for every manufacturing field Environmental management system acc. to DIN EN ISO 14001 Occupational health and safety management acc. to NLF/ILO-OSH and DIN ISO 45001 Energy management system acc. to DIN EN ISO 50001



400 Hz Ground Power

GP 400 Sy

400 Hz Ground Power supply cable - Symmetrical

for fixed installation

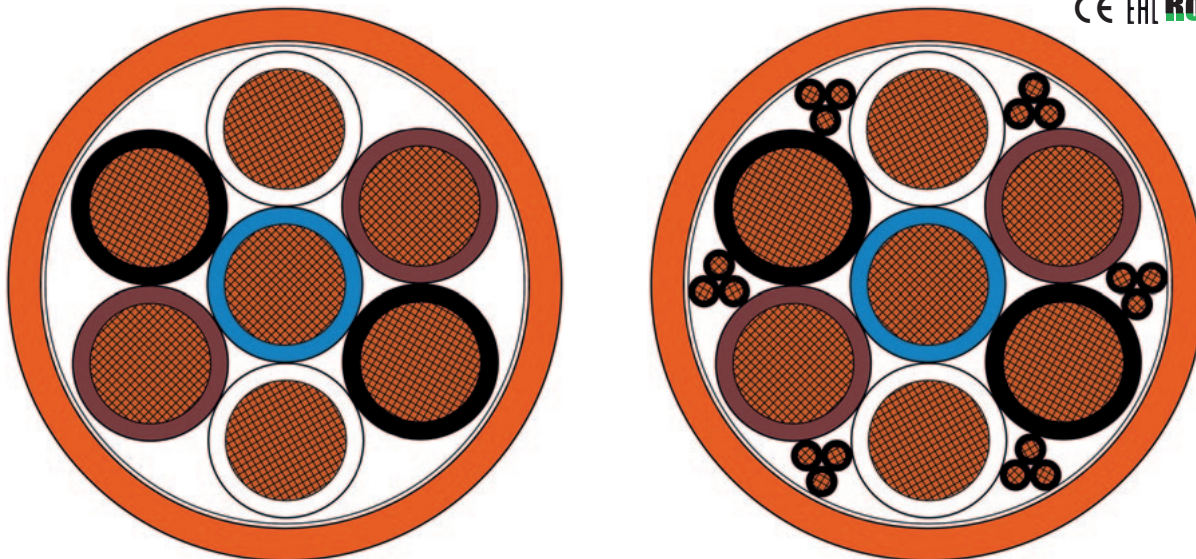

Application: For use as fixed installation cable in 400 Hz systems, e.g. between 400 Hz generator and cable dispenser.

Construction:

Conductor:	bare copper strands
Insulation	35,0mm ² : PVC 1,0mm ² : SABIX®C
Colour code:	control cores: black with numbers 1-18 neutral core: blue phase core: white, brown, black (two conductors of the same colour form the phase)
Stranding:	phase conductor concentrically around the neutral conductor, control conductors as triple in the fillers
Sheath material:	PVC
Sheath colour:	orange
Marking:	SAB BRÖCKSKES · D-VIERSEN · GP 400 Sy 7x35,0mm ² +6x3x1,0mm ² 3400-7213 CE and continuous meter marking

Technical Data:

Nominal voltage:	U ₀ /U 0,6/1 kV
Testing voltage:	core/core 4000 V AC
Min. bending radius	
fixed laying:	4 x d
flexible application:	8 x d
Temperature range	
fixed laying:	-40/+70 °C
flexible application:	+5/+70 °C
Absence of harmful substances:	acc. to RoHS directive of the European Union

Outstanding features:



- reduced outer diameter

Item. no.	no. of cores x cross section n x mm ²	outer-Ø approx. mm	copper figure kg/km	cable weight ≈ kg/km	DC resistance at 20°C max. Ω/km	voltage drop [mV/(A*m)]
34007210	7 x 35,0	37,0	2352,0	3003	35,0 mm ² : 0,554	35,0 mm ² : 1,108
34007213	7 x 35,0 + 6 x 3 x 1,0	37,0	2524,8	3125	35,0 mm ² : 0,554 1,0 mm ² : 19,5	35,0 mm ² : 1,108 1,0 mm ² : 39,0

Other dimensions and colours are possible on request.



Also available
with 24 control cores!

400 Hz Ground Power

GP 400 SC

400 Hz Ground Power supply cable - SingleCore

GP 400 QF

400 Hz Ground Power supply cable - QuadFlex

for flexible application

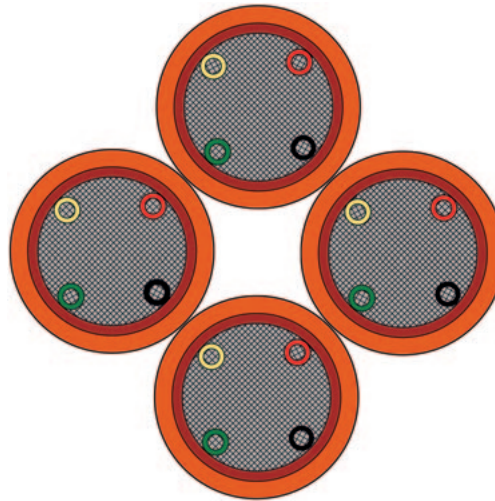
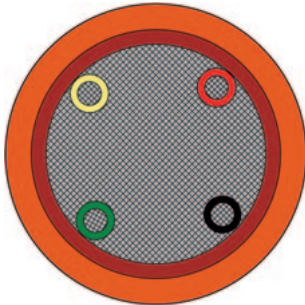

Application: For use in flexible applications, e.g. mobile generators, cable dispensers in the ground or on the passenger bridge.

Construction:

Conductor:	tinned copper strands
Insulation:	SABIX®
Colour code:	control cores: red, black, green, yellow power supply core: red
Stranding:	control cores within the power supply core
Sheath material:	PUR
Sheath colour:	orange
Stranding:	GP 400 QF: openly stranded
Marking	SAB BRÖCKSKES · D-VIERSEN ·
GP 400 SC:	GP 400 SC (50,0mm ² +4x1,0mm ²) 3400-1321 CE and continuous meter marking
Marking	SAB BRÖCKSKES · D-VIERSEN ·
GP 400 QF:	GP 400 QF 4x(50,0mm ² +4x1,0mm ²) 3400-4321 L1 resp. L2 resp. L3 resp. N CE and continuous meter marking

Technical Data:

Nominal voltage:	U ₀ /U 115/200 V
Max. permissible operating voltage*:	U ₀ /U 0,6/1 kV
Testing voltage:	core/core 4000 V AC
Min. bending radius	
fixed laying:	4 x d
flexible application:	6 x d
Temperature range	
fixed laying:	-50/+90 °C
flexible application:	-40/+90 °C
Halogen-free:	acc. to IEC 60754-1 + VDE 0482-754-1
Oil resistance:	very good - TMPU acc. to EN 50363-10-2 + VDE 0207-363-10-2
Weather resistance:	very good
Absence of harmful substances:	acc. to RoHS directive of the European Union

Outstanding features:



- low capacity insulation
- abrasion-resistant PUR sheath
- control cores symmetrically arranged
- cold flexible
- halogen-free
- oil resistant
- weather resistant

* using all wires on one potential

Item. no.	no. of cores x cross section n x mm ²	outer-Ø approx. mm	copper figure kg/km	cable weight ≈ kg/km	DC resistance at 20°C max. Ω/km	voltage drop [mV/(A*m)]
GP 400 SC						
34001321	1 x (50,0 + 4 x 1,0)	15,6	524,0	587	50,0 mm ² : 0,393 1,0 mm ² : 20,0	50,0 mm ² : 0,786 1,0 mm ² : 40,0
34001421	1 x (70,0 mm ² + 4 x 1,0 mm ²)	17,7	739,2	800	70,0 mm ² : 0,277 1,0 mm ² : 20,0	70,0 mm ² : 0,554 1,0 mm ² : 40,0
34001521	1 x (95,0 mm ² + 4 x 1,0 mm ²)	19,6	940,8	1032	95,0 mm ² : 0,210 1,0 mm ² : 20,0	95,0 mm ² : 0,420 1,0 mm ² : 40,0
GP 400 QF						
34004321	4 x (50,0 mm ² + 4 x 1,0 mm ²)	37,5	2096,0	2401	50,0 mm ² : 0,393 1,0 mm ² : 20,0	50,0 mm ² : 0,786 1,0 mm ² : 40,0
34004421	4 x (70,0 mm ² + 4 x 1,0 mm ²)	42,5	2956,8	3264	70,0 mm ² : 0,277 1,0 mm ² : 20,0	70,0 mm ² : 0,554 1,0 mm ² : 40,0

Other dimensions and colours are possible on request.

400 Hz Ground Power

GP 400 7F

400 Hz Ground Power supply cable - SevenFlex

for flexible application

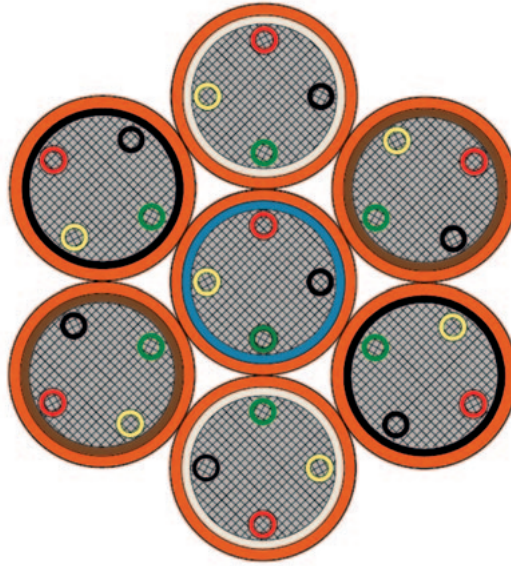

Application: Symmetrical construction with high flexibility. Minimum bending radius (easy to coil even in tight spaces) and high quality electrical performance (low voltage drop and low voltage unbalance). Can be used over longer distances.

Construction:

Conductor:	tinned copper strands
Isolierhülle:	SABIX®
Colour code:	control cores: red, black, green, yellow power supply core: red
Stranding:	control cores within the power supply core
Sheath material:	PUR
Sheath colour:	orange
Stranding:	openly stranded
Marking:	SAB BRÖCKSKES · D-VIERSEN · Special GP 400 35,0mm ² +4x1,0mm ² 3400-9006 CE and continuous meter marking

Technical Data:

Nominal voltage:	U ₀ /U 0,6/1 kV
Testing voltage:	core/core 4000 V AC
Min. bending radius	
fixed laying:	4 x d
flexible application:	6 x d
Temperature range	
fixed laying:	-50/+90 °C
flexible application:	-40/+90 °C
Absence of harmful substances:	acc. to RoHS directive of the European Union

Outstanding features:



- low capacity insulation
- abrasion-resistant PUR sheath
- control cores symmetrically arranged inside power supply core
- cold flexible
- halogen-free
- oil resistant
- weather resistant

Item. no.	no. of cores x cross section n x mm ²	outer-Ø approx. mm	copper figure kg/km	cable weight ≈ kg/km	DC resistance at 20°C max. Ω/km	voltage drop [mV/(A*m)]
34009006	7 x (35,0 mm ² + 4 x 1,0 mm ²)	40,2	2654,4	2969,2	35,0 mm ² : 0,554 1,0 mm ² : 19,5	35,0 mm ² : 1,108 1,0 mm ² : 39,0

Other dimensions and colours are possible on request.

400 Hz Ground Power

GP 400 SF

400 Hz Ground Power supply cable - SymmetricalFlex

for flexible application

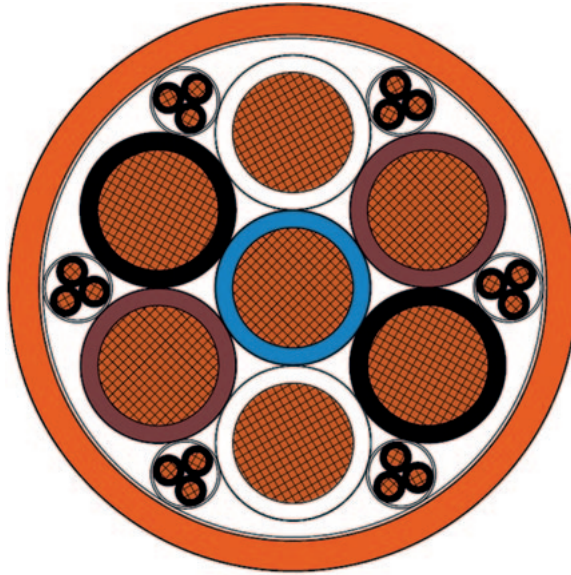

Application: For the application as fixed supply cable easy to install or for flexible use without elevated mechanical stress for hand-held applications for example mobile GPUs. Optimised flexibility due to smooth core and sheath materials that allows easy installation and handling.

Construction:

Conductor:	bare copper strands
Insulation:	SABIX®
Colour code:	control cores: black with numbers 1-18 neutral core: blue phase core: white, brown, black (two cores of the same colour form the phase)
Stranding:	Phase conductors concentrically around neutral core, control cores as tripple in the interstices, triple wrapped with non-woven tape, all elements twisted in specially adjusted layers, non-woven tape overlapping wrapped
Sheath material:	special compound
Sheath colour:	orange
Marking:	SAB BRÖCKSKES · D-VIERSEN · GP 400 SF 7x35,0mm ² +6x3x1,0mm ² 3400-7223 CE and continuous meter marking

Technical Data:

Nominal voltage:	U ₀ /U 0,6/1 kV
Testing voltage:	core/core 4000 V AC
Current carrying capacity:	with reference to LV112-3 and an application based current time profile as well as the following application conditions - ambient temperature up to max. 52°C - two phases of the same colour interconnected to one core - further cores (25 mm ² blue and 1mm ² / 34007123) resp. (35 mm ² blue and 1mm ² / 34007223) without charge - single laying at or on surfaces
34007123	231 A for max. 10 min. 262,5 A for max. 5 min. 294 A for max. 10 sec. 420 A for max. 2 sec.
34007223	286 A for max. 10 min. 325 A for max. 5 min. 364 A for max. 10 sec. 520 A for max. 2 sec.
Min. bending radius	
<i>fixed laying:</i>	4 x d
<i>flexible application:</i>	6 x d
Temperature range	
<i>fixed laying:</i>	-40/+70 °C
<i>flexible application:</i>	-20/+70 °C
Absence of harmful substances:	acc. to RoHS directive of the European Union

Outstanding features:



- low capacity insulation
- very flexible and smooth handling
- also usable as a supply cable directly on the aircraft
- very good installation in narrowest spaces
- good resistance and low wear

Item. no.	no. of cores x cross section n x mm ²	outer-Ø approx. mm	copper figure kg/km	cable weight ≈ kg/km	DC resistance at 20°C max. Ω/km	voltage drop [mV/(A*m)]
34007123	7 x 25,0 mm ² + 6 x 3 x 1,0 mm ²	32,4	1852,8	2245,5	25,0 mm ² : 0,780 1,0 mm ² : 19,5	25,0 mm ² : 1,560 1,0 mm ² : 39,0
34007223	7 x 35,0 mm ² + 6 x 3 x 1,0 mm ²	37,0	2524,8	2934,5	35,0 mm ² : 0,554 1,0 mm ² : 19,5	35,0 mm ² : 1,108 1,0 mm ² : 39,0

Other dimensions and colours are possible on request.



Also available with 24 control cores!

400 Hz Ground Power

GP 400 SF S

400 Hz Ground Power supply cable

for flexible application

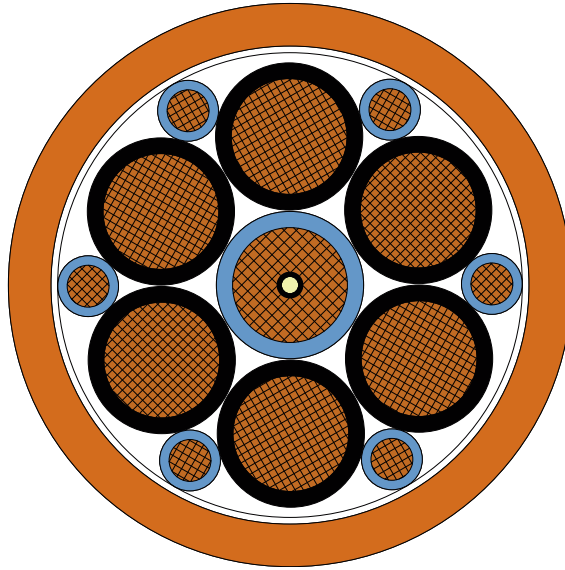

Application: For the application as cable chain cables in energy supply chains or as Festoon cable on passenger boarding bridges.

Construction:

Conductor:	tinned copper strands, fine wires
Insulation:	SABIX®
Colour code:	6,0 mm ² : blue 35,0 mm ² : black with numbers, 2 x 1-3 blue
Stranding:	35,0 mm ² : neutral core with strain relief in the core, wrapped with non-woven tape
Wrapping:	non-woven tape
Sheath material:	PUR
Sheath colour:	orange
Marking:	SAB BRÖCKSKES · D-VIERSEN · GP 400 SF S 7x35,0mm ² +6x6,0mm ² 3400-6230 CE and continuous meter marking

Technical Data:

Nominal voltage:	U ₀ /U 0,6/1 kV
Testing voltage:	core/core 4000 V AC
Min. bending radius continuously flexible:	7,5 x d
Temperature range fixed laying:	-50/+90 °C
flexible application:	-40/+90 °C
Absence of harmful substances:	acc. to RoHS directive of the European Union

Outstanding features:



- low capacity insulation
- abrasion-resistant PUR sheath
- cold flexible
- halogen-free
- oil resistant
- weather resistant

Item. no.	no. of cores x cross section n x mm ²	outer-Ø approx. mm	copper figure kg/km	cable weight ≈ kg/km	DC resistance at 20°C max. Ω/km
34006230	7 x 35,0 mm ² + 6 x 6,0 mm ²	38,7	2707,2	3174	35,0 mm ² : 0,565 6,0 mm ² : 3,39

Other dimensions and colours are possible on request.

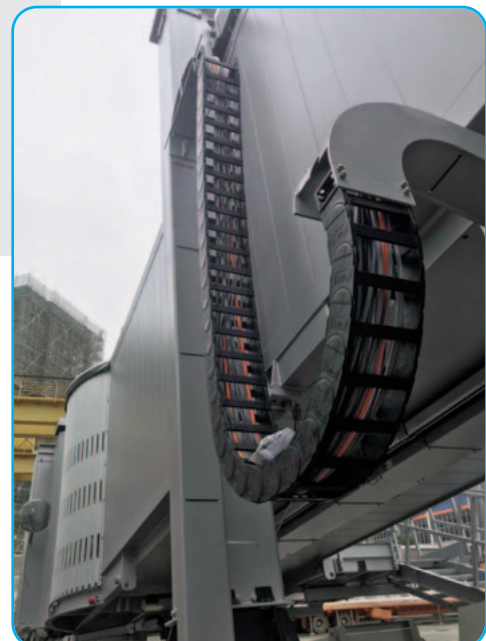

400 Hz Ground Power

GP 400 SF S

400 Hz Ground Power control cable

for flexible application

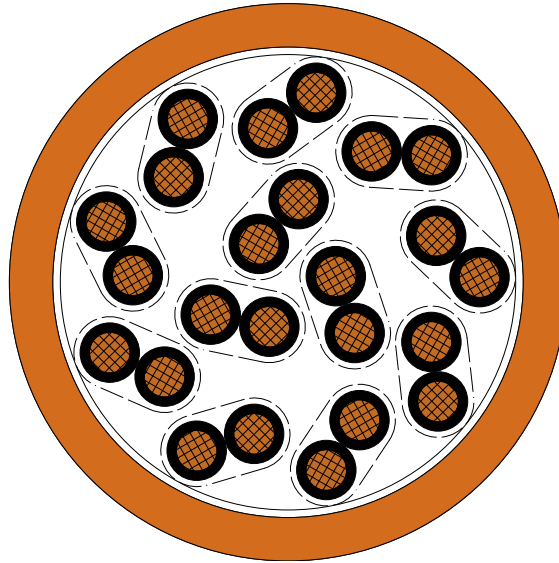

Application: For the application as cable chain cables in energy supply chains or as Festoon cable on passenger boarding bridges.

Construction:

Conductor:	bare copper strands, fine wires
Insulation:	SABIX®
Colour code:	black with numbers 1 - 24
Stranding:	cores twisted to pairs, optimized twisting of pairs in layers
Sheath material:	PUR
Sheath colour:	orange
Marking:	SAB BRÖCKSKES · D-VIERSEN · GP 400 SF S 12x2x1,5mm ² 3400-9028 CE and continuous meter marking

Technical Data:

Nominal voltage:	300/500 V
Testing voltage:	core/core 4000 V AC
Min. bending radius <i>continuously flexible:</i>	7,5 x d
Temperature range <i>fixed laying:</i>	-50/+90 °C
<i>flexible application:</i>	-40/+90 °C
Absence of harmful substances:	acc. to RoHS directive of the European Union

Outstanding features:



- low capacity insulation
- abrasion-resistant PUR sheath
- cold flexible
- halogen-free
- oil resistant
- weather resistant

Item. no.	no. of cores x cross section n x mm ²	outer-Ø approx. mm	copper figure kg/km	cable weight ≈ kg/km	DC resistance at 20°C max. Ω/km
34009028	12 x 2 x 1,5 mm ²	23,0	345,6	480	12,0 mm ² : 13,7

Other dimensions and colours are possible on request.



400 Hz Ground Power

GP 400 SC DC

Ground Power supply cable 28 V DC - SingleCore Direct Current

for flexible application

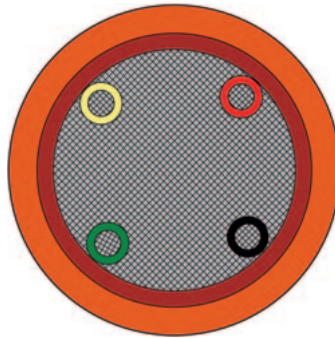

Application: For use in flexible applications, e.g. mobile generators, cable dispensers in the ground or on the passenger bridge at 28 V DC.

Construction:

Conductor:	tinned copper strands
Insulation:	SABIX®
Colour code:	control cores: red, black, green, yellow power supply core: red
Stranding:	control cores within the power supply core
Sheath material:	PUR
Sheath colour:	orange
Marking:	SAB BRÖCKSKES · D-VIERSEN · GP 400 SC DC (120,0mm ² +4x1,0mm ²) 3400-1621 and continuous meter marking

Technical Data:

Voltage:	28 V DC
Testing voltage:	core/core 600 V AC
Min. bending radius	
fixed laying:	4 x d
flexible application:	6 x d
Temperature range	
fixed laying:	-50/+90 °C
flexible application:	-40/+90 °C
Halogen-free:	acc. to IEC 60754-1 + VDE 0482-754-1
Oil resistance:	very good - TMPU acc. to EN 50363-10-2 + VDE 0207-363-10-2
Weather resistance:	very good
Absence of harmful substances:	acc. to RoHS directive of the European Union

Outstanding features:



- low capacity insulation
- abrasion-resistant PUR sheath
- control cores symmetrically arranged inside power supply core
- cold flexible
- halogen-free
- oil resistant
- weather resistant

Item. no.	no. of cores x cross section n x mm ²	outer-Ø approx. mm	copper figure kg/km	cable weight ≈ kg/km	DC resistance at 20°C max. Ω/km	voltage drop [mV/(A*m)]
34001621	1 x (120,0 mm ² + 4 x 1,0 mm ²)	22,2	1296,0	1331	120 mm ² : 0,164 1,0 mm ² : 20,0	120 mm ² : 0,328 1,0 mm ² : 40,0

Other dimensions and colours are possible on request.

Determination of the derating curve acc. to LV112-3 based on item no. 3400-1621

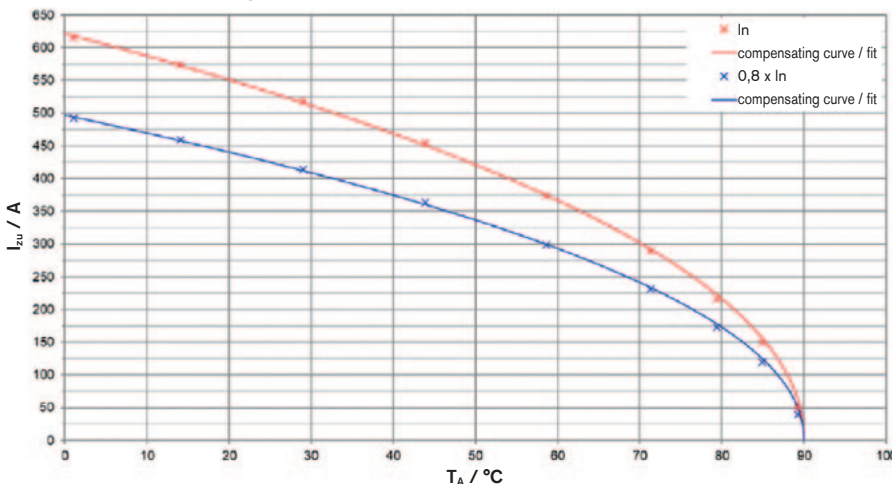

Reference values of current carrying capacity from derating curve

for 20°C ambient temperature, taken from 80% curve: **440 A**

for 20°C ambient temperature, taken from 100 % curve: **550 A**

precondition:
laying separately free in air

400 Hz Ground Power

GP 400 SF 28V DC

400 Hz Ground Power supply cable 28 V DC

for flexible application

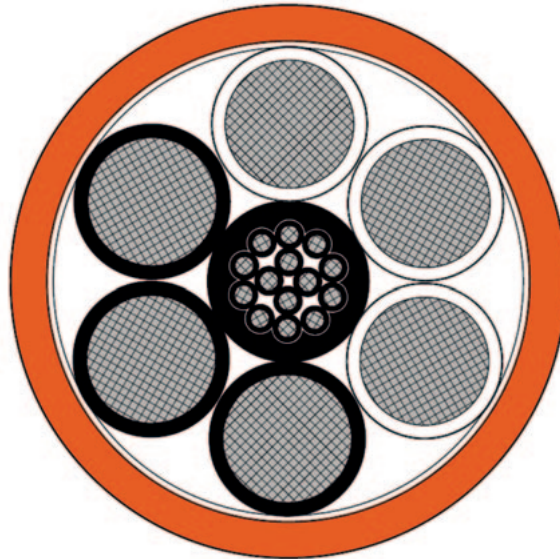

Application: For the application as fixed supply cable with optimised installation or for a flexible hand-held application without elevated mechanical stress for example mobile GPUs. Excellent flexibility due to smooth core and sheath materials make possible an easy laying and handling.

Construction:

Conductor:	tinned copper strands, fine wires
Insulation:	SABIX®
Colour code:	1,0 mm ² : black cores with consecutive numbers 1 - 14 40,0 mm ² : white cores with consecutive numbers 1 - 3, black cores with consecutive numbers 1 - 3
Stranding:	in layers
Sheath material:	PVC
Sheath colour:	orange
Marking:	SAB BRÖCKSKES · D-VIERSEN · GP 400 SF 28V DC 6x40,0mm ² +14x1,0mm ² 3400-9020 CE and continuous meter marking

Technical Data:

Voltage:	28 V DC
Testing voltage:	core/core 600 V AC
Min. bending radius	
fixed laying:	4 x d
flexible application:	6 x d
Temperature range	
fixed laying:	-40/+70 °C
flexible application:	-20/+70 °C
Oil resistance:	acc. to internal standard
Absence of harmful substances:	acc. to RoHS directive of the European Union

Outstanding features:



- low capacity insulation
- extremely flexible and smooth handling
- also usable as supply cable at the aircraft itself
- very good installation in narrowest spaces
- good resistance characteristics also against wear and tear

Item. no.	no. of cores x cross section n x mm ²	outer-Ø mm	copper figure kg/km	cable weight ≈ kg/km	DC resistance at 20°C max. Ω/km
34009020	6 x 40,0 + 14 x 1,0	min. 36,0 max. 37,99	2438,4	2910	40,0 mm ² : 0,500 1,0 mm ² : 20,0

Other dimensions and colours are possible on request.

400 Hz Ground Power

SAB 400 Hz cable for mobile GPUs with connectors

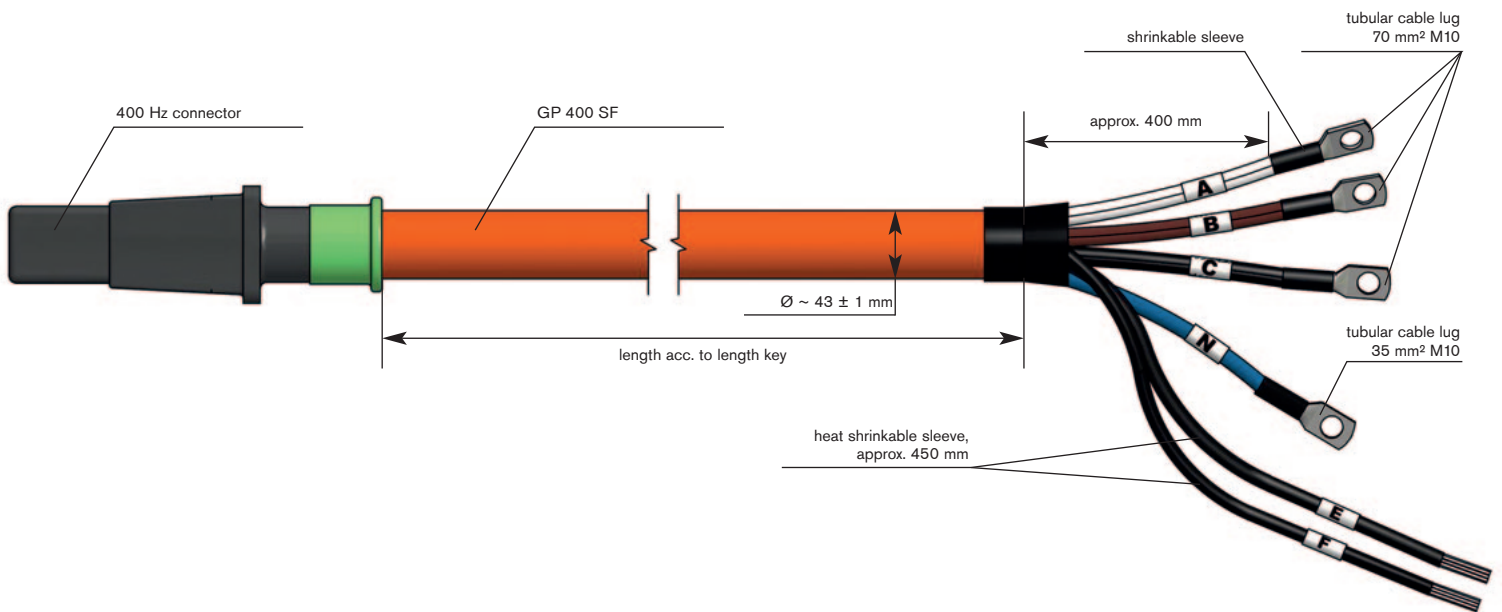

Pin assignment:

400 Hz connector	cable	connection piece
pin A	2 x wh (35 mm ²)	tubular cable lug 70 mm ² , M10
pin B	2 x bn (35 mm ²)	tubular cable lug 70 mm ² , M10
pin C	2 x bk (35 mm ²)	tubular cable lug 70 mm ² , M10
pin N	1 x bu (35 mm ²)	tubular cable lug 35 mm ² , M10
pin E	cores 1-9 (1 mm ²)	cores pulled into shrinkable sleeves, core ends untreated
pin F	cores 10-18 (1 mm ²)	cores pulled into shrinkable sleeves, core ends untreated

Weight:

connector and tubular cable lugs	cable
approx. 3 kg	approx. 3,2 kg/m

Configuration examples:

item no.	length „L“ in cm
S3400-3003-01000	100
S3400-3003-02000	200

400 Hz Ground Power

Plug'n'Play - ready harnessed with connector

Ready-to-connect ground power cables with connectors



- SAB Bröckskes** also supplies 400 Hz cables ready for installation. Various 400 Hz connectors available.
- on request also with tubular cable lugs.
 - each cable harness is safely and individually packed.
 - each product is tested for function.
 - on request with test report for 100% documentation.

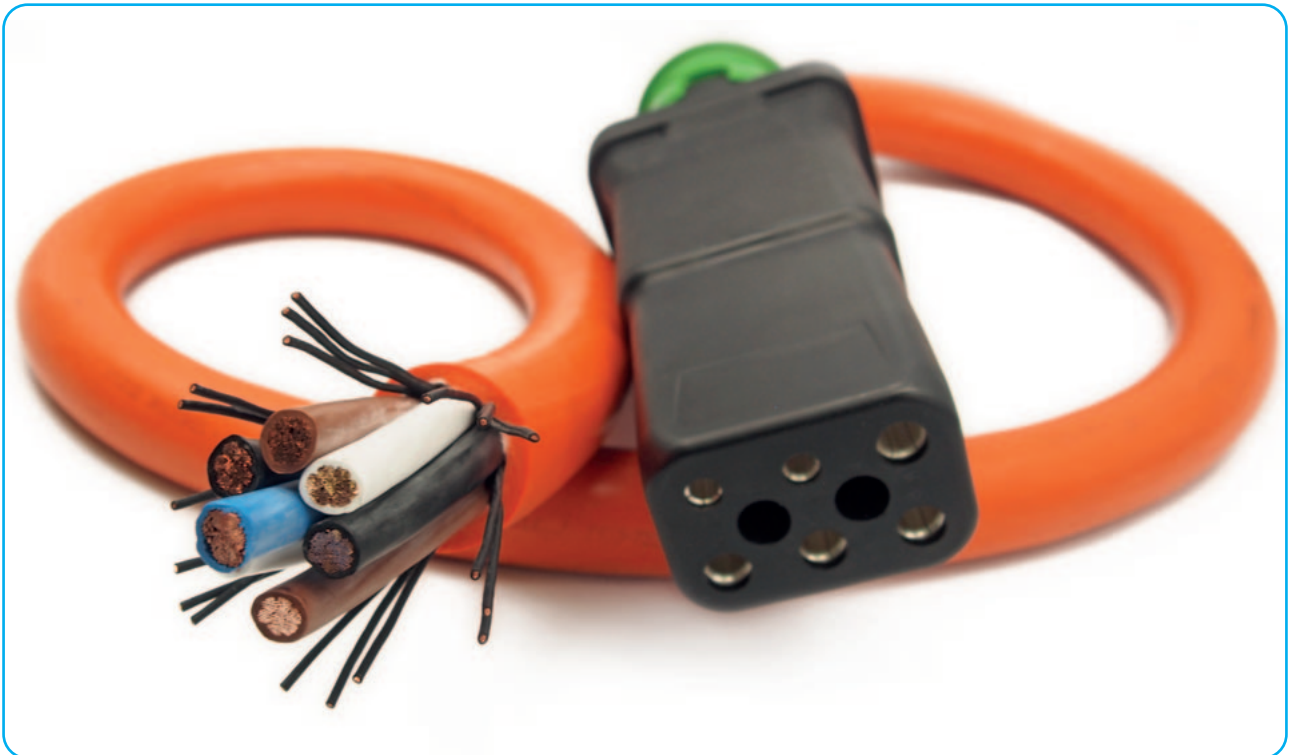

Please also take note of our brochure

„Cables for Airport Equipment”

400 Hz

GROUND POWER CABLES

CABLES

FOR AIRPORT EQUIPMENT















www.sab-cable.com



Cables for Airport Equipment

Content

Cables for Airport Equipment		
■ BB 380 Boarding Bridge	cable for the flexible application in passenger bridges	16
		
Cable Track Cables		
■ S 200 SD 200 S 200 C SD 200 C SD 200 C TP	extremely flexible TPE/PUR control cable with numbered cores for continuous movement . . . extremely flexible TPE/PUR data cable with coloured cores for continuous movement continuously flexible TPE/PUR control cable with numbered cores and overall copper screen continuously flexible TPE/PUR data cable with coloured cores and overall copper screen continuously flexible TPE/PUR paired data cable with coloured cores and overall copper screen	17
■ S 910 P	 continuously flexible TPE/PUR single conductor	18
■ S 910 CP	 continuously flexible TPE/PUR single conductor with overall copper screen	18
		
■ SL 841 C	 combined TPE/PUR motor connection cable with overall copper screen 0.6/1 kV	19
		
■ S PB 640 UL ■ S PN 667 ■ PN 662 AIR ■ Cable harnessing	Bus Cables  highly flexible PUR Profibus-DP cable with UL recognition, CSA approval  Profinet type C, continuously flexible with UL recognition, CSA approval Industrial Ethernet Cable CAT 5 - Profinet type B, for flexible applications Ethernet cable on both side 4-pole Lemo male connector	20 20 21 21
		
■ CATLine CAT 6 S ■ CATLine CAT 6A S ■ CATLine CAT 7A S	Industrial Ethernet Leitungen  CAT 6 Gigabit Ethernet cable, suitable for cable tracks with UL recognition, CSA approval  CAT 6A Gigabit Ethernet cable, suitable for cable tracks with UL recognition, CSA approval  CAT 7A Gigabit Ethernet cable, suitable for cable tracks with UL recognition, CSA approval	22 22 22
		
■ USB 3.0 cable ■ USB 3.0 cable	USB 3.0 cables with moulded type A and Micro-B male connector with moulded type A male connector and type A female connector	23 23



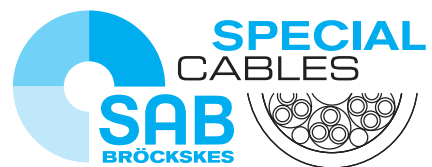

SAB Bröckskes GmbH & Co. KG

Grefrather Str. 204 - 212 b

41749 Viersen · GERMANY

Tel.: +49/2162/898-0

Fax: +49/2162/898-101

www.sab-cable.com

info@sab-cable.com